



UAN: 021-111-203-203

Email: sales@interwoodmobel.com

www.interwood.pk | www.corporate.interwood.pk

Twitter /interwoodmobel Instagram /interwoodcorporate

For corporate queries email:

corporate@interwoodmobel.com

## SHOWROOMS

### Islamabad/ Rawalpindi

- Golra Showroom  
Plaza - 39, Furniture Market  
Opposite CMT, Golra Road  
Rawalpindi / Islamabad 45710
- DHA Islamabad Showroom  
Main GT Road, Opposite Gate 4,  
DHA Phase 2,  
Islamabad, 45710
- I-9 Showroom  
Plot # 390, Street No. 16,  
Potohar Road  
(Near I-9 Police Station),  
I-9/3, Islamabad,  
Islamabad Capital Territory, 45710

### Lahore

- Garden Town Showroom  
7, Babar Block  
New Garden Town, Lahore,  
Punjab, 54600
- DHA-Y Block Showroom  
211-Y block, Commercial Area  
Sector Y DHA Phase 3,  
Lahore, Punjab, 54000

### Peshawar

- Hayatabad Showroom  
Saif Shopping Mall  
Phase 3 Chowk  
Jamrud Road, Peshawar

### Karachi

- LuckyOne Showroom  
Shop No. LG-14, Lower Ground Level,  
LuckyOne Mall,  
Rashid Minhas Road,  
Karachi, Sindh, 74600
- DHA Bukhari Showroom  
Building No. 43-C,  
Bukhari Lane No. 11, Bukhari Commercial Area,  
Phase 6 DHA, Karachi, Sindh, 74600

### Gujranwala

- Estate No. 1, Plot No. 1-A  
Small Industrial Estate,  
Near Suzuki Motors - GT Road,  
Gujranwala, Punjab, 52250

CERTIFIED BY:



The mark of responsible forestry  
FSC® C136041

December, 2021

YAGREEN 111-927-336

# DOORS

## CATALOGUE

### 2022

EDITION-1

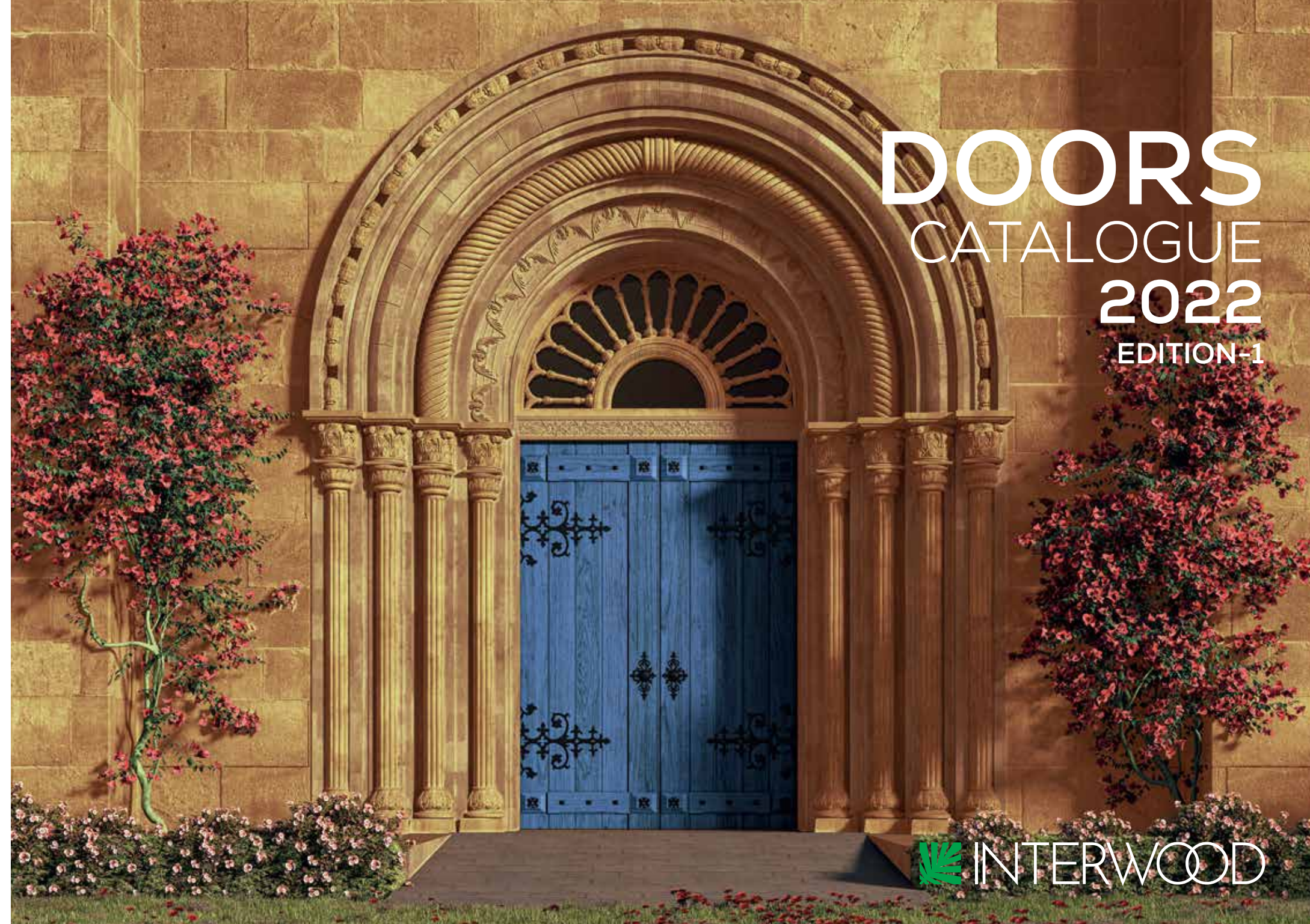



## PURPOSE

---

To inspire everyone for a better lifestyle.

## VISION

---

Becoming the global lifestyle trendsetter, loved by all at home and at the workplace.

## OUR VALUES

---

Love for Customers  
Service | Respect | Agility

Re-Imagine  
Growth | Innovation | Automation

Transparency  
Honesty | Openness | Accountability

Collaboration  
Connection | Empowerment



## CHAIRMAN'S MESSAGE

Interwood is today a household brand name that is synonymous with high quality international standard furniture, including home & office furniture, kitchens, doors, wardrobes, flooring, accessories and so much more. In addition to catering to homes, however, we also lend our brand of ready made and customized furnishing solutions to hospitals, educational institutions, banks, corporations, hotels, luxury residences, retail brands and mega infrastructural projects like international airports.

We are humbled by our achievements and are grateful to our partners, our competitors and of course our customers in helping us reach to where we are today. We remain ever committed to continue evolving and delivering high quality and affordable products to our customers.



# INDEX

ABOUT US

INTRODUCTION

SERIES-100

THERMOSET DOORS | 01

SERIES-200

MELAMINE DOORS | 05

SERIES-300

VENEER DOORS | 09

SERIES-400

PANEL DOORS | 35

SERIES-500

LACQUER DOORS | 65

COMPONENTS

DOORS COMPONENTS | 79

## SERIES-100

Technologically advanced and environmentally friendly, Series 100 smartly integrates the vacuum press technology to create innovative solutions for your home and office. These thermoset doors leave a silent impression on your visitors and the various finish options allow you to choose a design that best suits your taste. The quality material falls well under the budget while providing easy maintenance for all.

---

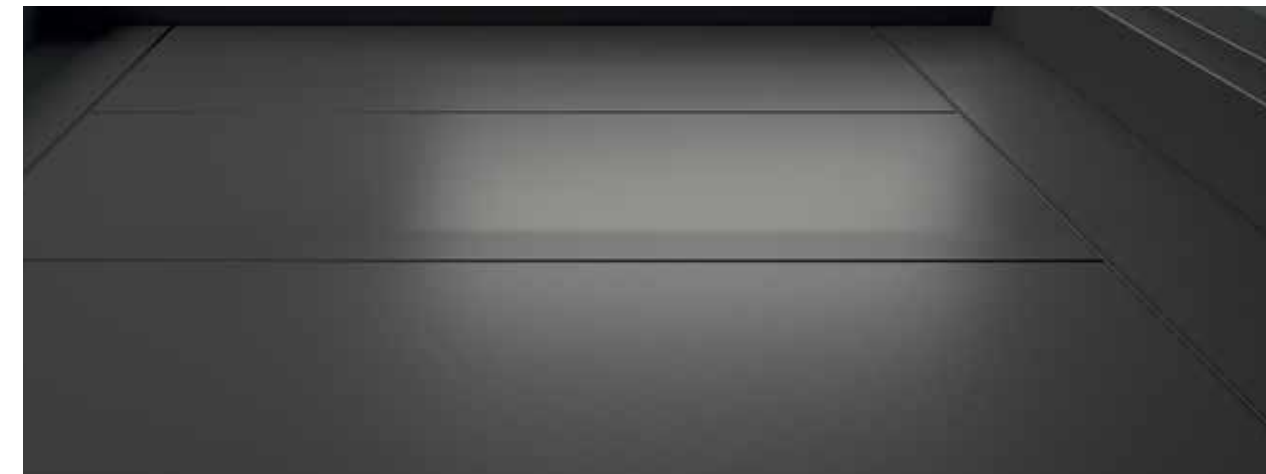



Graphite Finish

# MIRA DOOR

Thermoset Hollow Door



White



Cedar Nobel



Graphite



White Glazed

SERIES-100



## SERIES-200

Manufactured with a distinct approach, our Series 200 is genuinely fascinating. Its design is meant to resist heat and minor scratches, these doors withstand ample time without fading that makes them a perfect choice for your home. These easy to maintain doors leaves a profound impression on your guests while being easy on your pocket. The beautiful shades and finishes allow you to explore the endless possibilities of your interior while providing easy maintenance. The detailed assembly with a metal jamb frame makes them durable for years to come.



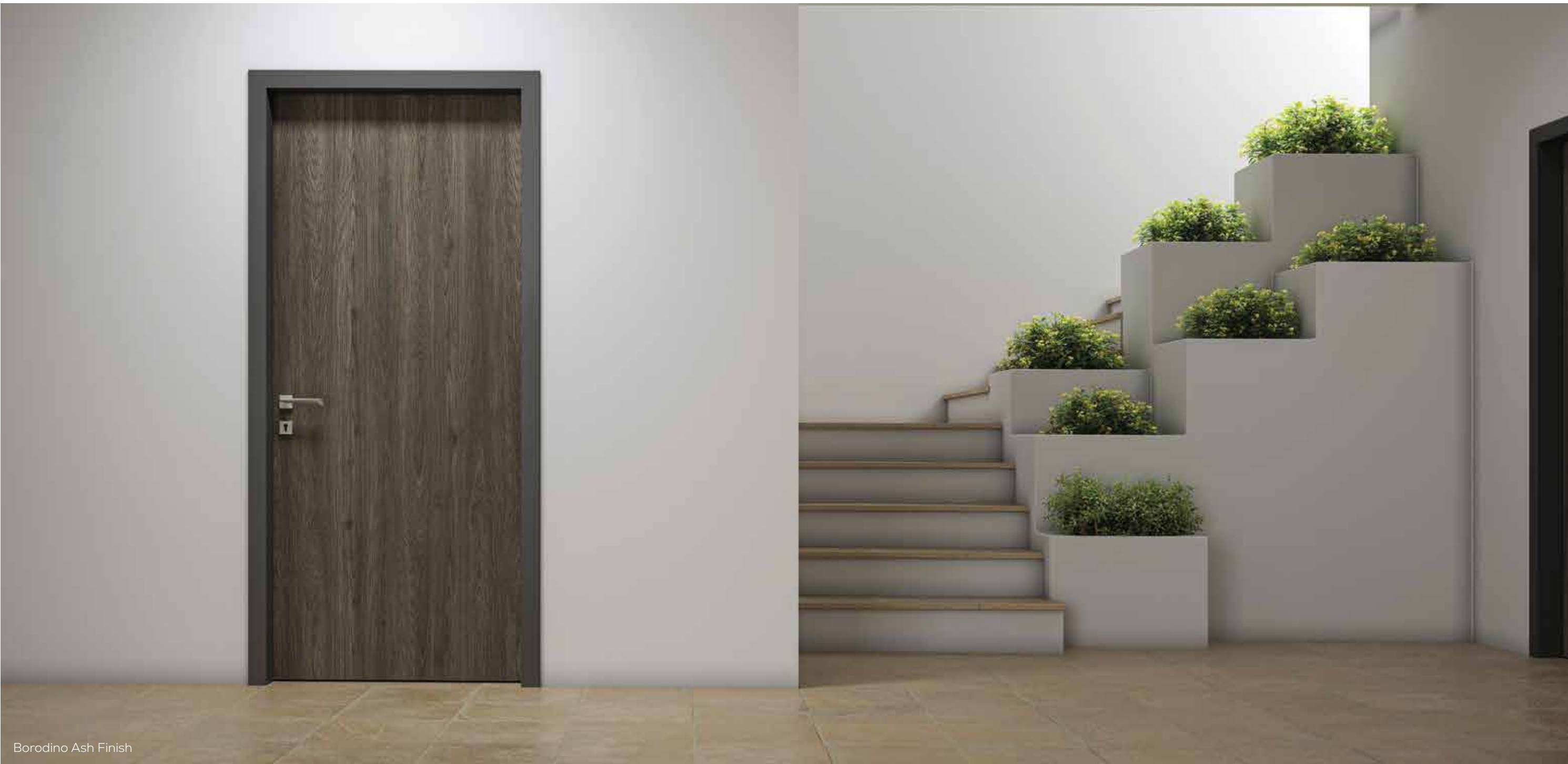

Borodino Ash Finish

# RENO DOOR

Melamine door available as Hollow and Solid core



White



Ivory



Oak White



Brown Oak

SERIES-200





## SERIES-300

Designed to fascinate you at the first glance, this series gracefully brings out the charm of natural wood. The trendy and chic designs are not only affordable but provide you with an opportunity to choose the best for your home and office. Our Series 300 is artfully manufactured with quality veneer with a wide range of finishes to commend all types of interiors. Our state-of-the-art facility continuously churns economical substitutes that assembled with jamb frame and architrave that is highly stable and provides a lasting durability.







Teak Veneer  
Jacobean Finish

# YORK DOOR

Solid Core Door



Ash Veneer  
White Finish



Beech Veneer  
Natural Finish



Mahogany Veneer  
Teak Finish



Teak Veneer  
Walnut Finish

SERIES-300



Mahogany Veneer  
Jacobean Finish

# FLUSH DOOR

Solid and Hollow Core Door



Beech Veneer  
Natural Finish



Beech Veneer  
Ginger Finish



Teak Veneer  
Teak Finish



Mahogany Veneer  
Jacobean Finish

SERIES-300





Mahogany Veneer  
Smoked Walnut Finish

# SCOT DOOR

Solid, Glazed and Mesh Core Door



Ash Veneer  
White Finish



Beech Veneer  
Natural Finish



Teak Veneer  
Walnut Finish



Mahogany Veneer  
Smoked Walnut Finish

SERIES-300



Mahogany Veneer  
Reproduction Mahogany Finish

# FILA DOOR

Solid and Hollow Core Door



Mahogany Veneer  
Teak Finish



Mahogany Veneer  
Rosewood Finish



Mahogany Veneer  
Repr. Mahogany Finish



Mahogany Veneer  
Jacobean Finish

SERIES-300





Mahogany Veneer  
Teak Finish

# CODA DOOR

Solid and Hollow Core Door



Teak Veneer  
Teak Finish



Mahogany Veneer  
Teak Finish



Mahogany Veneer  
Jacobean Finish



Mahogany Veneer  
Walnut Finish

SERIES-300



Beech Veneer  
Black Finish

# TRACE DOOR

Solid and Hollow Core Door



Beech Veneer  
Natural Finish



Beech Veneer  
Jacobean Finish



Beech Veneer  
Teak Finish



Beech Veneer  
Walnut Finish

SERIES-300





Teak Veneer  
Natural Finish

# CANTO DOOR

Solid and Hollow Core Door



Beech Veneer  
Natural Finish



Mahogany Veneer  
Walnut Finish



Teak Veneer  
Walnut Finish



Ash Veneer  
Smoked Walnut Finish

SERIES-300



Teak Veneer  
Natural Finish

# ORDO DOOR

Solid and Hollow Core Door



Mahogany Veneer  
Smoked Walnut Finish



Mahogany Veneer  
Walnut Finish



Mahogany Veneer  
Repr. Mahogany Finish



Mahogany Veneer  
Jacobean Finish

SERIES-300





Mahogany Veneer  
Teak Finish

# ZAG DOOR

Solid and Hollow Core Door



Beech Veneer  
Natural Finish



Beech Veneer  
Walnut Finish



Beech Veneer  
Teak Finish



Mahogany Veneer  
Jacobean Finish

SERIES-300



Walnut Veneer  
Natural Finish

# FORMA DOOR

Solid and Hollow Core Door



Beech Veneer  
Natural Finish



Mahogany Veneer  
Teak Finish



Beech Veneer  
Ginger Finish



Beech Veneer  
Jacobean Finish

SERIES-300





Mahogany Veneer  
Reproduction Mahogany Finish

# FREE DOOR

Solid Core Door



Ash Veneer  
White Finish



Mahogany Veneer  
Rosewood Finish



Mahogany Veneer  
Repr. Mahogany Finish



Mahogany Veneer  
Jacobean Finish

SERIES-300



Beech Veneer  
White Finish

# MOD DOOR

Solid and Hollow Core Door



Ash Veneer  
White Finish



Beech Veneer  
Natural Finish



Beech Veneer  
Ginger Finish



Mahogany Veneer  
Jacobean Finish

SERIES-300



## SERIES-400

These easily become the visual focus of any room with their impressive aesthetics. Our Series 400 is stained rather than painted, allowing the wood to show its natural grain. It houses a wide range of classic designs with a classic impression altogether. Tailored with solid wood rails, these doors allow you to choose from a wide variety of options in wood, stains and finishes. The leading edge fabrication creates an elegant surface with an ability to withstand wear and tear while having a swift and convenient installation.





Mahogany Wood/ Veneer  
Teak Finish

# TRIA DOOR

Solid, Engineered and Glazed Panel Door



Ash Wood/Veneer  
White Finish



Beech Wood/Veneer  
Ginger Finish



Mahogany Wood/Veneer  
Teak Finish



Teak Wood/Veneer  
Jacobean Finish

SERIES-400





Mahogany Wood / Veneer  
Rosewood Finish

# LOGICA DOOR

Engineered, Glazed and Mesh Panel Door



Mahogany Wood/Veneer  
Teak Finish



Ash Wood/Veneer  
Walnut Finish



Beech Wood/Veneer  
Walnut Finish



Mahogany Wood/Veneer  
Rosewood Finish

SERIES-400



Yellow Southern Pine Wood / Veneer  
Weathered Grey Finish

# LINIA DOOR

Solid, Engineered and Glazed Panel Door



Ash Wood/Veneer  
White Finish



Mahogany Wood/Veneer  
Teak Finish



Beech Wood/Veneer  
Smoked Walnut Finish



Mahogany Wood/Veneer  
Walnut Finish

SERIES-400





Yellow Southern Pine Wood / Veneer  
Weathered Grey Finish

# BARN DOOR

Solid Door



Yellow Southern Pine Wood  
White Finish



Yellow Southern Pine Wood  
Off-White Finish



Yellow Southern Pine Wood  
Sage Green Finish



Yellow Southern Pine Wood  
Black Finish

SERIES-400





Teak Wood / Veneer  
Natural Finish

# LOUVER DOOR

Solid Panel Door



Ash Wood/Veneer  
White Finish



Mahogany Wood/Veneer  
Teak Finish



Beech Wood/Veneer  
Smoked Walnut Finish



Beech Wood/Veneer  
Smoked Walnut Finish

SERIES-400





Beech Wood / Veneer  
Natural Finish

# AQUA DOOR

Solid, Glazed and Mesh Panel Door



Ash Wood/Veneer  
White Finish



Beech Wood/Veneer  
Natural Finish



Mahogany Wood/Veneer  
Teak Finish



Mahogany Wood/Veneer  
Rosewood Finish

SERIES-400



Mahogany Wood / Veneer  
Walnut Finish

# QUARTZ DOOR

Engineered Panel Door



Beech Wood/Veneer  
Natural Finish



Mahogany Wood/Veneer  
Teak Finish



Mahogany Wood/Veneer  
Jacobean Finish



Ash Wood/Veneer  
Teak Finish

SERIES-400





Mahogany Wood/Veneer  
Teak Finish

# REGENCY DOOR

Engineered, Glazed and Mesh Panel Door



Ash Wood/Veneer  
White Finish



Ash Wood/Veneer  
Teak Finish



Mahogany Wood/Veneer  
Teak Finish



Beech Wood/Veneer  
Walnut Finish

SERIES-400



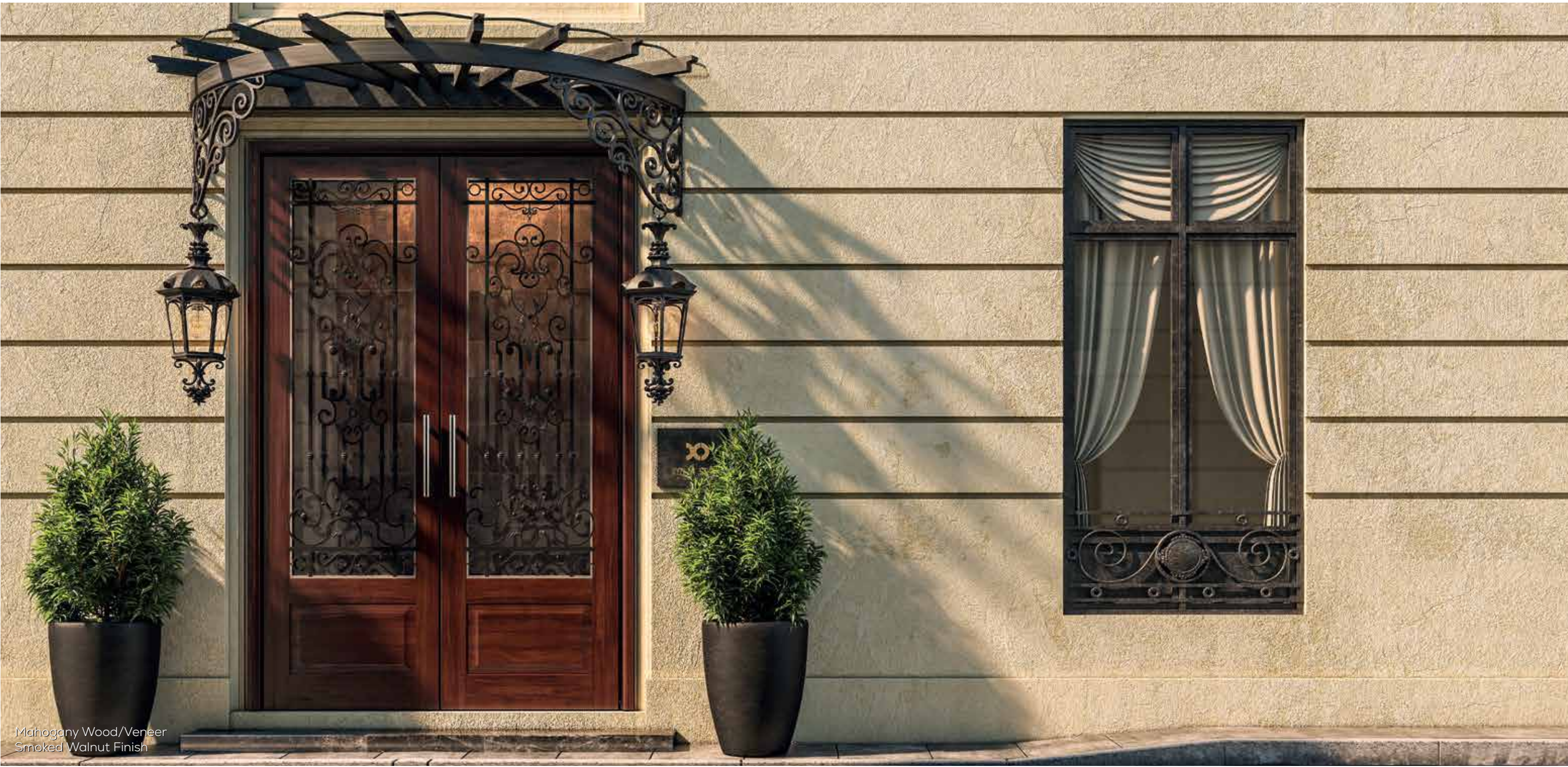

Mahogany Wood/Veneer  
Smoked Walnut Finish

# EZIO DOOR

Glazed Panel Door



Ash Wood/Veneer  
White Finish



Ash Wood/Veneer  
Weathered Grey Finish



Mahogany Wood/Veneer  
Jacobean Finish



Mahogany Wood/Veneer  
Rosewood Finish

SERIES-400





Mahogany Wood/Veneer  
Walnut Finish

# FORT DOOR

Solid, Engineered, Glazed and Mesh Panel Door



Ash Wood/Veneer  
White Finish



Beech Wood/Veneer  
Natural Finish



Mahogany Wood/Veneer  
Weathered Grey Finish



Mahogany Wood/Veneer  
Teak Finish

SERIES-400





Ash Wood/Veneer  
Teak Finish

## STRIP DOOR

Solid, Engineered, Glazed and Mesh Panel Door



Ash Wood/Veneer  
White Finish



Beech Wood/Veneer  
Natural Finish



Mahogany Wood/Veneer  
Jacobean Finish



Mahogany Wood/Veneer  
Teak Finish

SERIES-400





Mahogany Wood/Veneer  
Teak Finish

# GOTHIC DOOR

Solid Door



Ash Wood/Veneer  
White Finish



Ash Wood/Veneer  
Weathered Grey Finish



Teak Wood/Veneer  
Walnut Finish



Mahogany Wood/Veneer  
Jacobean Finish

SERIES-400





Ash Wood/ Veneer  
Black Finish

# LEXUS DOOR

Solid and Engineered Panel Door



Beech Wood/Veneer  
Natural Finish



Mahogany Wood/Veneer  
Jacobean Finish



Mahogany Wood/Veneer  
Teak Finish



Ash Wood/Veneer  
White Finish

SERIES-400





Beech Wood/Veneer  
White Finish

## FRENCH DOOR

Glazed Door



Ash Wood/Veneer  
White Finish



Beech Wood/Veneer  
Natural Finish



Mahogany Wood/Veneer  
Smoked Walnut Finish



Mahogany Wood/Veneer  
Rosewood Finish

SERIES-400



## SERIES-500

Envisioned with a chic and cosmopolitan approach, our Series 500 has designs made with an aesthetic purpose in creating an impression of what lies ahead. The painted surfaces are trendy yet timeless.

The solid light shades reflect serenity while the gleaming finishes effortlessly make the interior stand out. It is manufactured in high-quality engineered medium-density fiberboard and assembled with a resilient jamb frame and architrave for durability and stability. These doors have a rich sense of character that makes them a premium choice for your home's interior.







Black Finish

# NERO DOOR

Available as Painted Door



White



Grey



Black



Glazed White

SERIES-500



White Finish

# SCURO DOOR

Available as Painted Door



White



Grey



Black



Glazed White

SERIES-500



# UMBRA DOOR

Available as Painted Door



White



Grey



Black



Glazed Grey

SERIES-500



Sage Green Finish

# MATERIAL & FINISHES

POLISH

FINISHES / WOOD  
SUBSTRATE

BEECH

ASH / OAK

MAHOGANY

TEAK

WALNUT

WHITE



X

X

X

OFF-WHITE

X



X

X

X

ANTIQUÉ GREY

X

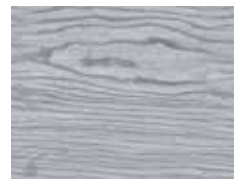

X

X

X

NATURAL



X



# MATERIAL & FINISHES

POLISH

FINISHES / WOOD  
SUBSTRATE

BEECH

ASH / OAK

MAHOGANY

TEAK

WALNUT

TEAK



X

GINGER



X

X

X

X

SMOKED OAK

X



X

X

X

JACOBÉAN



X















X



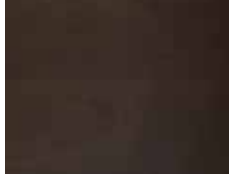



# MATERIAL & FINISHES

POLISH

FINISHES / WOOD SUBSTRATE	BEECH	ASH / OAK	MAHOGANY	TEAK	WALNUT
OPERA WALNUT	X	X	X	X	
SMOKED WALNUT		X			X
REPRODUCTION MAHOGANY					
WALNUT					X

# MATERIAL & FINISHES

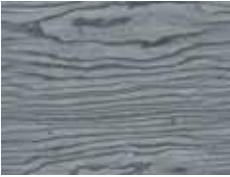
POLISH

FINISHES / WOOD SUBSTRATE	BEECH	ASH / OAK	MAHOGANY	TEAK	WALNUT
MARGOSA	X	X		X	X
ROSEWOOD	X	X		X	X
WEATHERED GREY			X	X	X
BLACK	X		X	X	X

# MATERIAL & FINISHES

PAINT

FINISHES / WOOD  
SUBSTRATE

SYP BRUSHED

MDF MATT

MDF GLOSS

WHITE

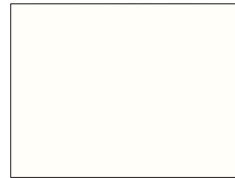

OFF-WHITE



SMOKED OAK



X

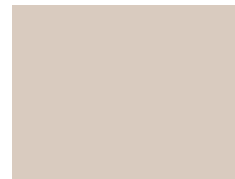

WEATHERED  
GREY

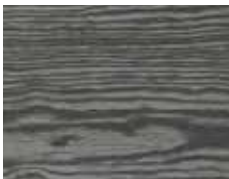

X



LIGHT GREY 2C

X



# MATERIAL & FINISHES

PAINT

FINISHES / WOOD  
SUBSTRATE

SYP BRUSHED

MDF MATT

MDF GLOSS

DARK GREY 6C

X



X

JADE GREEN



X

X

SAGE GREEN



X

CHARCOAL GREY



BLACK

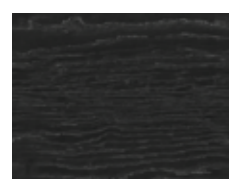

X





# ARCHITRAVES



01

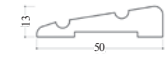

DR-517



02

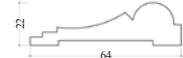

DR-502



03



DR-501C



DR-501B

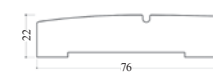

DR-M-ARC76X22A



07



DR-M-ARC100X22



08

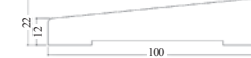

DR-M-ARC100X22B | DR-V-ARC100X18A  
DR-TH-ARC100X18A



09



DR-M-ARC100X22C | DR-V-ARC100X18B  
DR-TH-ARC100X18B



04

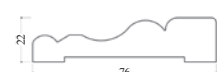

DR-M-ARC76X22C | DR-V-ARC76X18  
DR-TH-ARC76X18



05

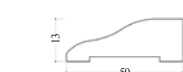

DR-V-ARC50X13A

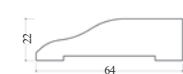

DR-V-ARC64X22A | DR-V-ARC64X18  
DR-TH-ARC64X18



06



DR-500A | DR-V-ARC50X12A  
DR-TH-ARC50X12A



DR-ARC64X22 | DR-V-ARC64X18  
DR-TH-ARC64X18

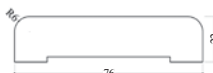

DR-M-ARC76X22B



10



DR-M-ARC150X44A



11

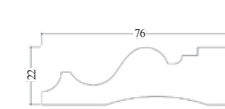

DR-M-ARC76X22D

\* Veneered, painted and thermoset architraves are available in 12mm & 18mm Thickness.  
\*\*Subject to machining and wood-working process there would be tolerance of (+/-1mm) in thickness of jamb frame, architrave, and door leaf.

# JAMB FRAME

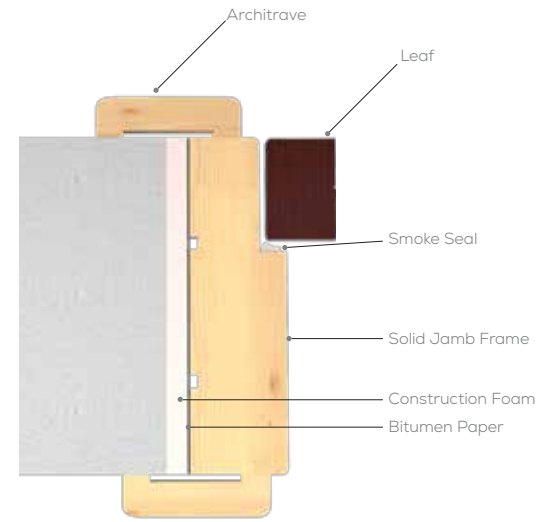

SOLID JAMB FRAME

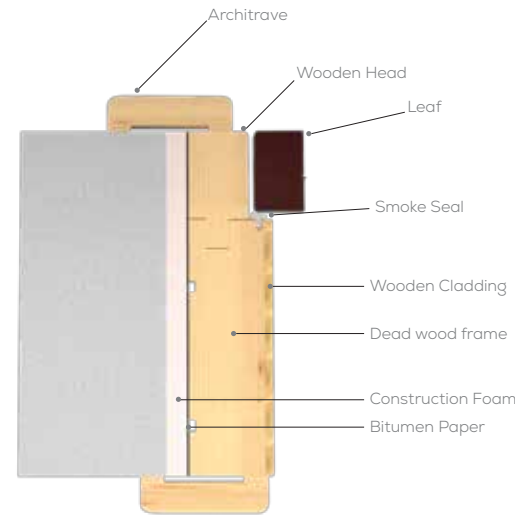

ENGINEERED JAMB FRAME  
(WITH CLADDING)

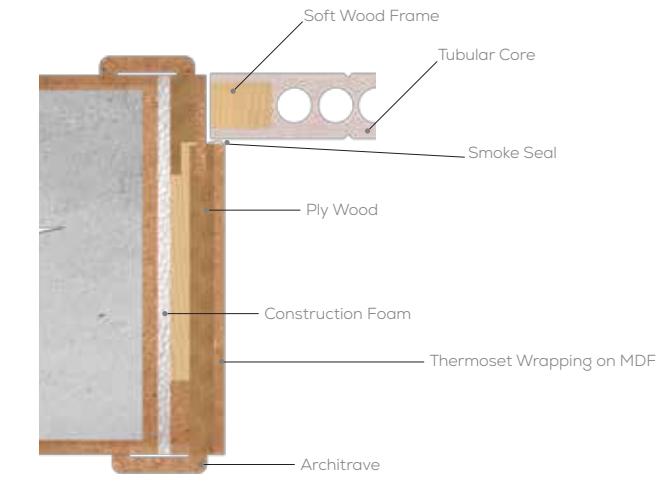

PLY WOOD JAMB FRAME

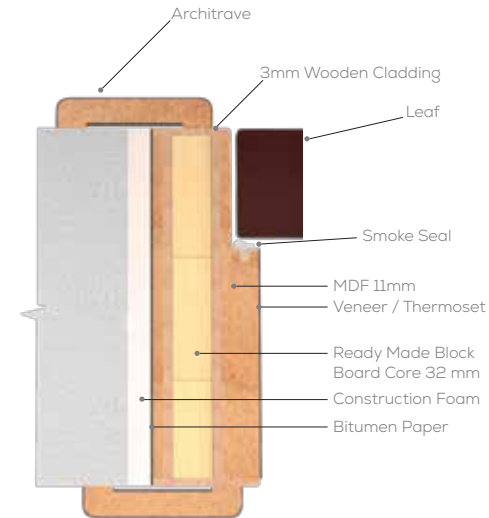

VENEERED JAMB FRAME  
(VENEERED, THERMOSET & PAINTED)

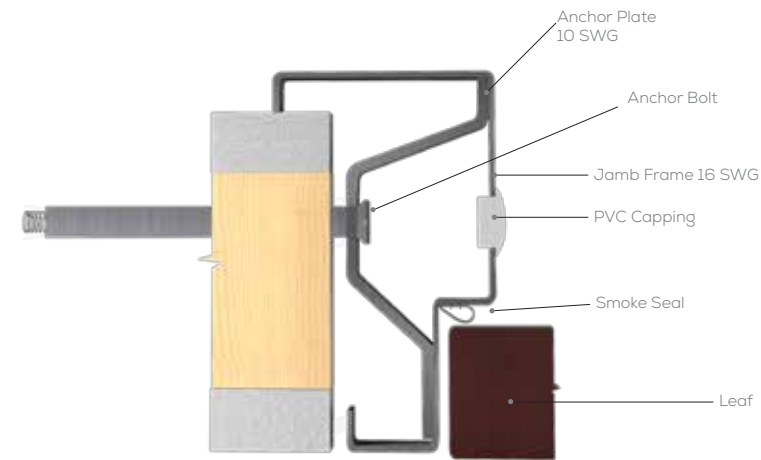

METAL JAMB FRAME

# JAMB FRAME

\* Subject to machining and wood-working process there would be tolerance of (+/-1mm) in thickness of jamb frame, architrave, and door leaf.



INTERWOOD



OUR TRUSTED  
CORPORATE PARTNERS



Explore more...



HOME FURNITURE



OFFICE FURNITURE



KITCHENS



WARDROBES

Find us on:



For corporate queries email:  
[corporate@interwoodmobel.com](mailto:corporate@interwoodmobel.com)

UAN: 021-111-203-203  
[www.interwood.pk](http://www.interwood.pk)  
[corporate.interwood.pk](mailto:corporate.interwood.pk)